



P.A. - S.p.A. - EQUIPAGGIAMENTI TECNICI DEL LAVAGGIO

VIA MILANO, 13 - CASELLA POSTALE 115 - 42048 RUBIERA (REGGIO EMILIA) - ITALY
 Tel. +39 0522 623611 - Fax. +39 0522 629600 - R.E.A. RE 156319 - R. I. RE 11535 - Mecc. RE 013446
 C.F. e P. IVA 01035950359 - Cap. Soc. i.v. € 750.000,00 - Codice Identificativo C.E.E. IT 01035950359
 ART. 2497 - BIS C.C. DIREZIONE E COORDINAMENTO BENETTI srl R.I. TRIB. DI RE 01480690351
<http://www.pa-etl.it> - E-mail: info@pa-etl.it



VNR- 0 VNR - I - Check Valve

Technical manual: **E 201**

Flow regulating valve.

Allows a one-way flow, preventing the back flow.



- **60.2030.00** VNR-I G 1/4 FF sst Ai 303 **DN8**
- **60.2040.00** VNR-O G 1/4 FF brass **DN8**
- **60.2020.00** VNR-I G 3/8 FF sst Ai 303 **DN10**
- **60.2050.00** VNR-O G 3/8 FF brass **DN10**
- **60.2065.00** VNR-O G 1/2 FF brass **DN15**
- **60.2070.00** VNR-I G1/2 FF sst Ai 303 **DN15**
- **60.2070.50** VNR-I 1/2 NPT FF sst Ai 303 **DN15**
- **60.2075.00** VNR-O G3/4 FF brass **DN20**
- **60.2080.00** VNR-I G 3/4 FF sst Ai 303 **DN20**

- Sturdy construction in Sst and brass.
- O ring Viton
- Return action of piston carried out by a spring
- Minimum pressure loss.
- Rapid intervention at minimum flow variation

Technical specifications

Max temperature: 90°C

Part number	Rated pressure	Permissible pressure	Minimum pressure intervention	Flow rate	Dimensions BxC	Inlet Outlet	MASSA
	bar - MPa						
60.2030.00	400 - 40	450 - 45	0.4 - 0.04	25	17x47	G1/4 FF	55
60.2040.00	150 - 15	160 - 16	0.4 - 0.04	25	17x47	G1/4 FF	58
60.2020.00	400 - 40	450 - 45	0.4 - 0.04	40	22x54	G3/8 FF	110
60.2050.00	150 - 15	160 - 16	0.4 - 0.04	40	22x54	G3/8 FF	115
60.2065.00	150 - 15	160 - 16	0.3 - 0.03	80	27x66	G1/2 FF	200
60.2070.00	400 - 40	450 - 45	0.3 - 0.03	80	27x66	G1/2 FF	190
60.2070.50	400 - 40	450 - 45	0.3 - 0.03	80	27x66	1/2NPT FF	190
60.2075.00	150 - 15	160 - 16	0.2 - 0.02	180	34x80	G3/4 FF	370
60.2080.00	400 - 40	450 - 45	0.2 - 0.02	180	34x80	G3/4 FF	350

Instruction manual, maintenance, installation, spare parts.
 For a correct utilization, follow the directions of this manual
Re-print them on the Use and Maintenance booklet of the machine.

n. 12.9201.00

DIMENSIONAL DRAWING

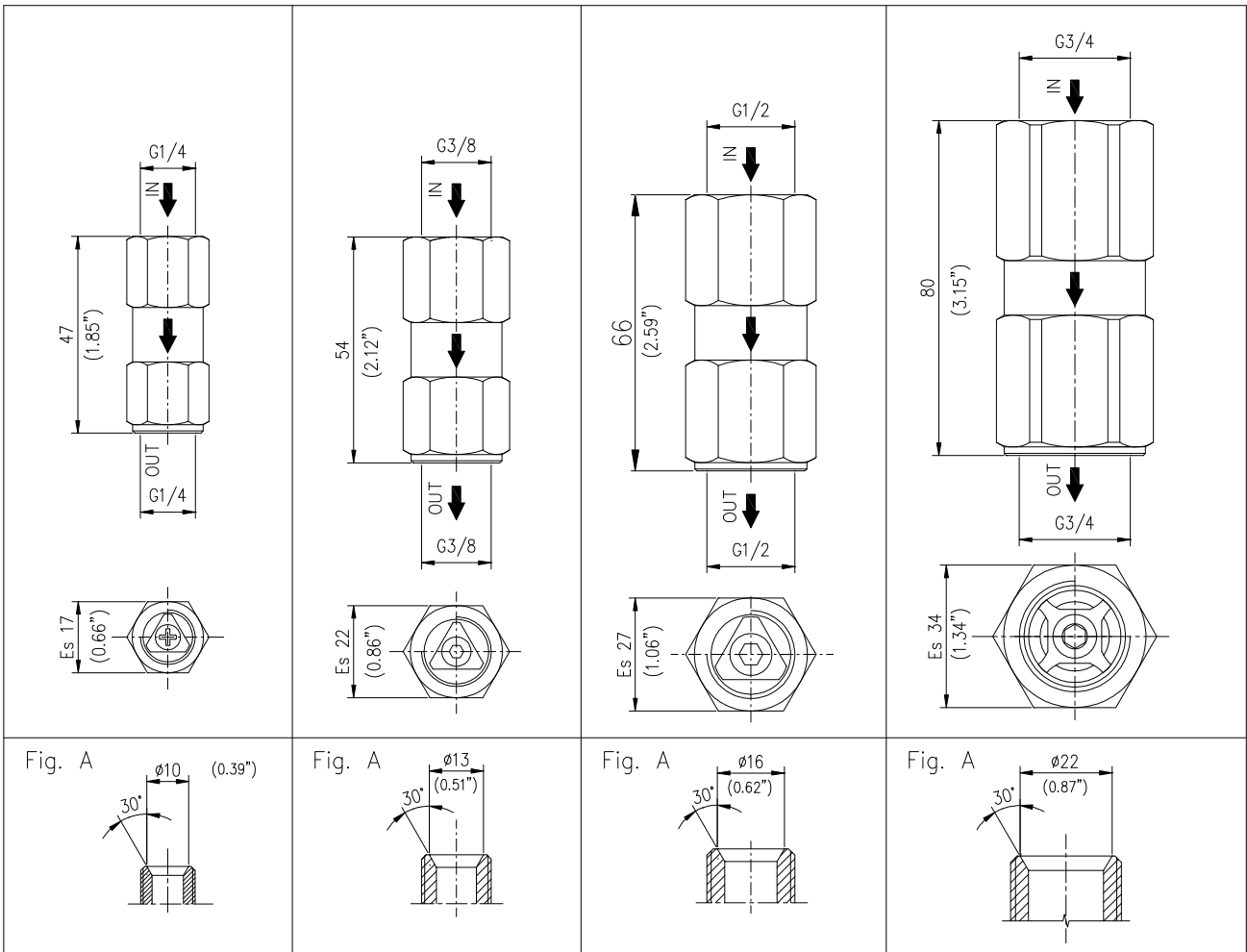

SU ENTRAMBI I LATI DELLA VALVOLA USARE RACCORDI SMUSSATI COME DA DISEGNO.
ON BOTH SIDES OF THE VALVE MAKE SURE TO USE CONNECTIONS CHAMFERED AS PER THE DRAWING.

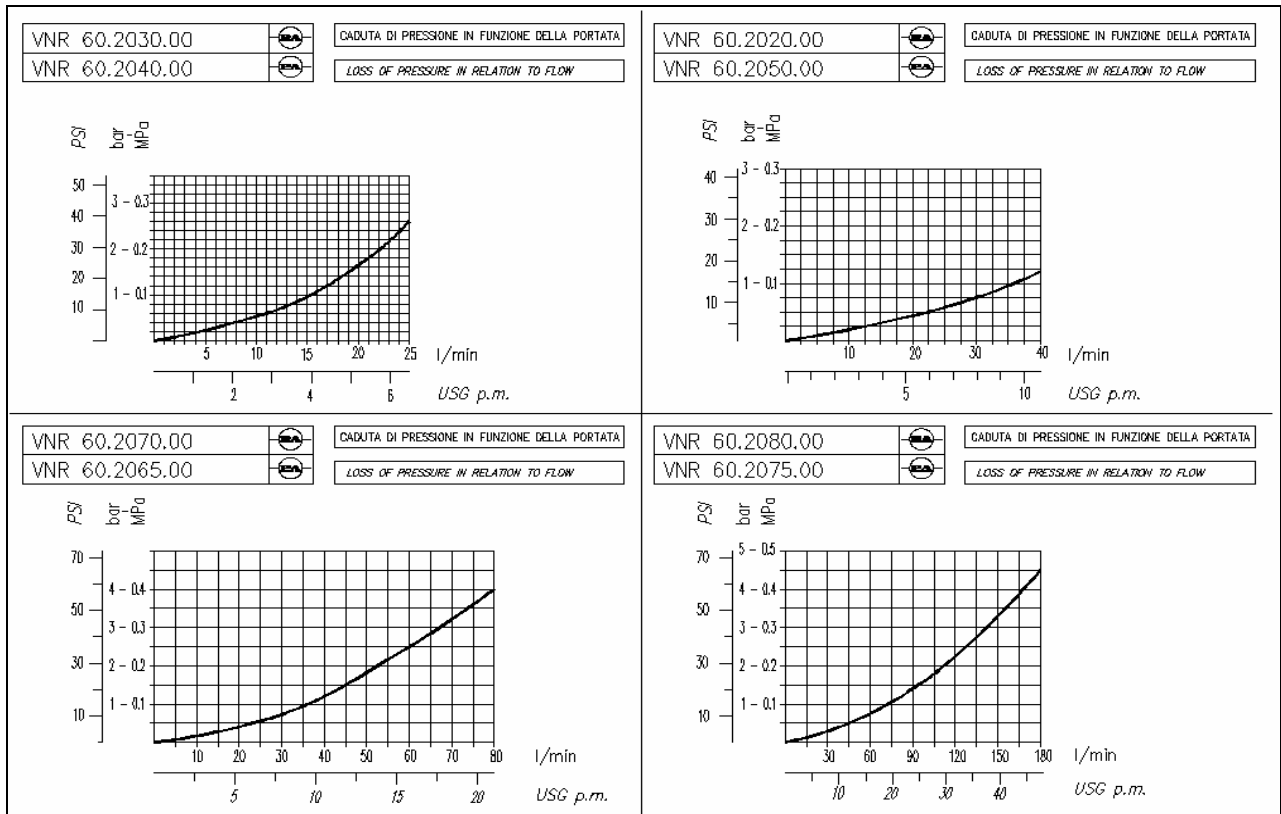

INSTRUCTIONS

SELECTION

This product is to be utilized with clean fresh water, even slightly additivated with normal detergents. For use involving different or corrosive liquids, contact the PA Technical department. Appropriate filtration should be installed when using unclean liquids. Choose the valve in line with the data of normal running (system rated pressure, max flow and max temperature). In any case, the pressure of the machine should not exceed the permissible pressure rate imprinted on the valve.

INSTALLATION

Make sure that the system is well proportioned. In particular, fit a piping system in line with the flow and pressure specifications. A bad proportioned system can ruin, without repair, all single components or damage the performance. This accessory, on a system that produces hot water, must be fitted in front of the heat generator. This product is bound to be incorporated on a finished machine. On a system that generates hot water, anticipate the fitting of accessories that limit the accidental increase of fluid temperature.

Always install a safety valve that protects the pressurized inlet channel.

ATTENTION: During assembly, respect the direction of the flow indicated on the valve. Use fittings internally chamfered. See fig.A dimensional drawing.

The valve is designed to work in installations that remain always full of water. If it appears necessary to empty the part of the circuit downstream of the valve, it is advisable to adopt an apparatus that guarantees a gradual start of the pump or the filling of the circuit at low pressure.

OPERATIONS

Water flows freely in a one-way direction, while it is totally blocked in the opposite direction.

Hermetic sealing is ensured by Viton seals.

The internal construction allows a rapid conversion in case of back flow and low pressure drop.

PROBLEMS AND SOLUTIONS

PROBLEMS	PROBABLE CAUSES	SOLUTIONS
Valve leakage	Worn out seal Material matter in the seat Worn out seat	Replace Remove and clean Replace valve body
Slow closure	Valve not properly sized Piping too small	Change type of valve Replace
Rupture of Or & spring	Fittings not chanfered internally	Fulfil internal chamfer as per fig.A dimensional drawing

REGULATIONS

The Project and construction of our products comply with: norm CEI EN 60335-2-79 first edition, published 1999-03 and relative variations to the project of norm prEN1829.

Read this manual before starting the assembly

For a correct utilization, follow the directions described in this manual and re-print them on the Use and maintenance manual of the machine.

The present manual is valid for all valves named **VNR - O VNR - I**

MAINTENANCE

Maintenance has to be carried out by **Specialized Technicians.**

SPECIAL: every 800 working hours(circa 20,000 cycles), control the wear of the seals and internal parts.

ATTENTION: reassemble the valve in the correct manner paying special attention to the flow direction indicated on the valve.

The manufacturer is not to be considered responsible for damage as a result from incorrect fitting and maintenance-

Technical data, descriptions and illustrations are indicative and liable to modification without notice

60.2020.00 VNR-I check valv. sst. 3/8FF Bsp

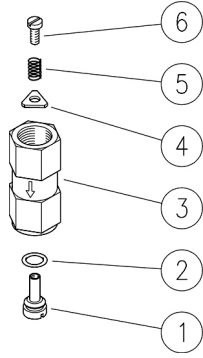

60.2050.00 VNR-O check valv. brass 3/8FF Bsp

Pos.	P/N	Description	Q.ty	K1	K2	K3	K4	
1	60.2023.51	Shutter pin, M4 Sst.	1					10
2	10.3055.14	O-ring 1,78x7,66 mm Vi85	1					10
3	60.2024.51	Housing -VNR-I, 3/8Bsp FF Sst. (1)	1					5
3	60.2024.31	Housing -VNR-O, 3/8Bsp FF brass (2)	1					5
4	60.2021.51	Triangular washer, 5x14x1,5 mm Sst.	1					10
5	60.2022.51	Spring, 0,5x6,3x12,5 mm Sst.	1					10
6	16.1831.00	Screw, ISO7380 M4x8 mm Sst.	1					10

(1) 60.2020.00 (2) 60.2050.00

60.2030.00 VNR-I check valv. sst. 1/4FF Bsp

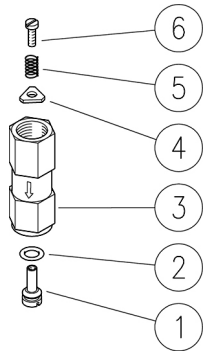

60.2040.00 VNR-O check valv. brass 1/4FF Bsp

Pos.	P/N	Description	Q.ty	K1	K2	K3	K4	
1	60.2034.51	Shutter pin, M3 Sst.	1					5
2	10.3049.14	O-Ring, 1,78x5,28 mm Vi 85	1					10
3	60.2031.51	Housing -VNR-I, 1/4Bsp FF Sst. (1)	1					5
3	60.2031.31	Housing -VNR-O, 1/4Bsp FF brass (2)	1					5
4	60.2033.51	Triangular washer, 4x11x1,5 mm Sst.	1					5
5	60.2032.51	Spring, 0,4x5,1x10,5 mm Sst.	1					5
6	16.1825.00	Screw, DIN7985 M3X6 mm Sst.	1					10

(1) 60.2030.00 (2) 60.2040.00

60.2065.00 VNR-O check valv. brass 1/2FF Bsp

60.2070.00 VNR-I check valv. sst. 1/2FF Bsp

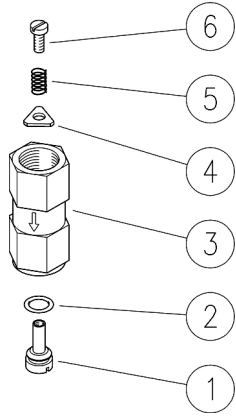

60.2070.50 VNR-I check valv. sst. 1/2FF Npt

Pos.	P/N	Description	Q.ty	K1	K2	K3	K4	
1	60.2062.51	Shutter pin, M6 Sst.	1					5
2	10.3175.14	O-ring 2,62x9.93mm Vi 85	1					10
3	60.2061.51	Housing -VNR-I, 1/2Bsp FF Sst. (1)	1					5
3	60.2071.51	Sst 1/2Npt FF body (2)	1					5
3	60.2061.31	Housing -VNR-O, 1/2Bsp FF brass (3)	1					5
4	60.2063.51	Triangular washer, 8x18x1,5 mm Sst.	1					10
5	60.2064.51	Spring, 0,7x9,6x14 mm Sst.	1					10
6	16.1832.00	Screw, ISO7380 M6x8 mm Sst.	1					10

(1) 60.2070.00 (2) 60.2070.50 (3) 60.2065.00

60.2075.00 VNR-O check valv. brass 3/4FF Bsp

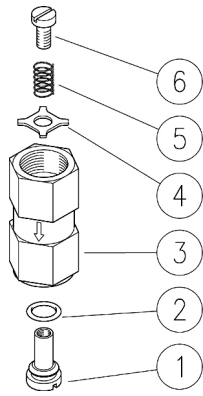

60.2080.00 VNR-I check valv. sst. 3/4FF Bsp

Pos.	P/N	Description	Q.ty	K1	K2	K3	K4	
1	60.2076.51	Shutter pin, M6 Sst.	1					10
2	10.3179.14	O-ring 2,62x13,1 mm Vi 85	1					10
3	60.2078.31	Housing -VNR-O, 3/4Bsp FF brass (1)	1					5
3	60.2081.51	Housing -VNR-I, 3/4Bsp FF Sst. (2)	1					5
4	60.2077.53	Sst washer, 8x22x2 mm	1					10
5	60.2064.51	Spring, 0,7x9,6x14 mm Sst.	1					10
6	16.1832.00	Screw, ISO7380 M6x8 mm Sst.	1					10

(1) 60.2075.00 (2) 60.2080.00

P.A. SpA EQUIPAGGIAMENTI TECNICI DEL LAVAGGIO

Via Milano, 13 42048 Rubiera - (RE) ITALY
Tel +39 0522 623611 (ric aut) - Fax +39 0522 629600
Info@pa-etl.it - www.pa-etl.it

**COMPANY WITH
QUALITY SYSTEM
CERTIFIED BY DNV**

= ISO 9001 =