



Electric Powered Pressure Washer Owner's Manual

Overview & Warnings	1
Grounding & Extension Cords	2
Safety Precautions	2-3
Assembly Instructions	4
Operating Instructions	5
Using the Accessories	6
Working with Detergent	7
Shutdown Instructions	8
Storage, Winterizing & Transport	9
Basic Maintenance	9,10
Troubleshooting	11,12
Warranty Information	13



KC2100EPC model shown.
May not be exactly as shown.

Customer Service Hotline:
1-866-939-6666
visit our website:
www.kodiakpower.ca

IMPORTANT: Do not operate this equipment until you have carefully read and understand all of the Owner's Manual. Carefully **read ALL Warnings, Safety Precautions, Assembly and Operating Instructions, Maintenance and Storage Information.**

Overview

NOTE: Check for visible shipping damage. Shipping damage will cause problems in the operation of this unit. Contact the Customer Service hotline immediately if there are missing or damaged parts. **Do not return this product to the store.**

Item Description

- 1 Gun assembly
- 2 Nozzle connector
- 3 Spray Lance
- 4 High pressure hose
- 5 Reversible cart handle
- 6 Spray nozzles
- 7 Nuts
- 8 Unloader
- 9 Water outlet
- 10 Water inlet
- 11 Front guard
- 12 Pump
- 13 Pump oil dipstick
- 14 Thermal protector valve
- 15 Detergent suction hose

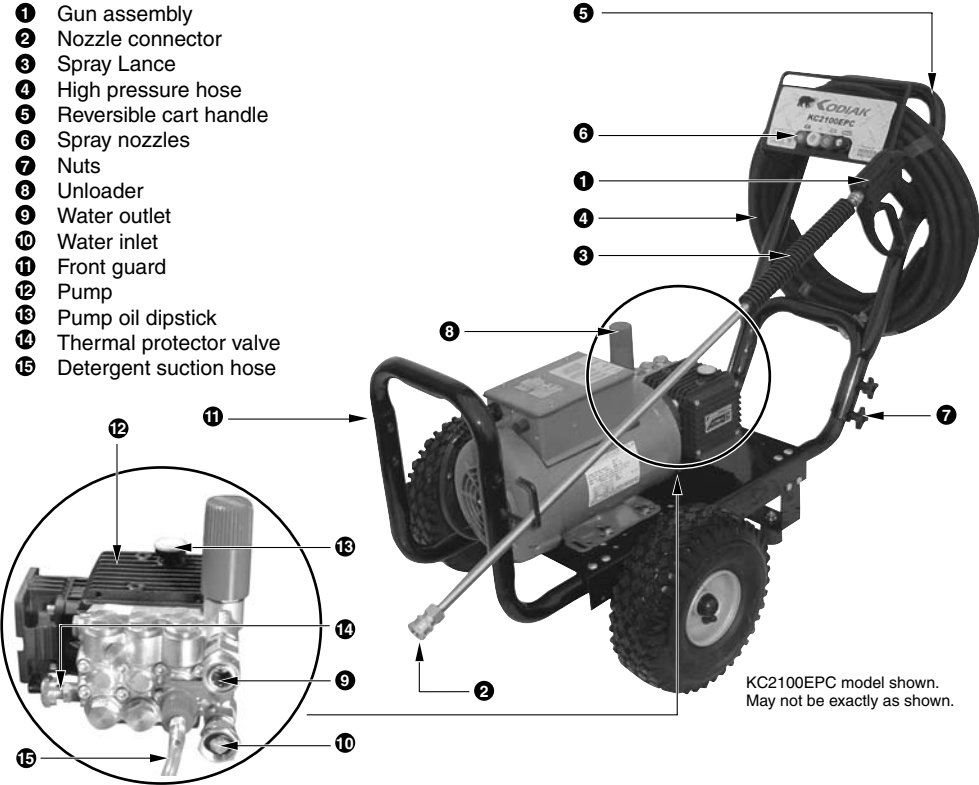

KC2100EPC model shown.
May not be exactly as shown.

Warning!

- Never** aim water spray at persons, animals, electrical devices, or the machine itself.
- Never** touch water spray.
- Never** use hot water.
- Never** operate pressure washer without the water turned on.
- Never** drink alcohol or use drugs while operating this equipment.
- Never** operate while standing in water.
- Never** touch plug with wet hands.
- Never** let electrical connections rest in water.
- Never** allow the pressure washer to freeze.



Always wear safety glasses and protective clothing.
Always ensure anyone operating this equipment, carefully reads and understands ALL important safety and equipment precautions.

Important Safety Precautions

Grounding Instructions

This product must be grounded. If it should malfunction or break-down, grounding provides a path of least resistance for electric current to reduce the risk of electric shock. This product is equipped with a cord having a grounding plug. The plug must be plugged into an appropriate outlet that is properly installed and grounded in accordance with all local codes and ordinances.

WARNING: Improper connection can result in a risk of electrocution. Check with a qualified electrician if you are in doubt as to whether the outlet is properly grounded.

DO NOT modify the plug provided with the unit; if it will not fit the outlet, have a proper outlet installed by a qualified electrician. Do not use any type of adaptor with this product.

Extension Cords

Extension cords are NOT recommended for this product. If an extension cord must be used, the following requirements must be met:

- 14-3 gauge minimum wire size up to 25 ft. cord.
- 12-3 gauge minimum wire size up to 50 ft. cord.
- Use only 3-wire extension cords that have 3-prong grounding type plugs and 3-pole cord connectors that accept the plug from the unit.

Use only extension cords that are intended for outdoor use. These extension cords are identified by the marking "Acceptable for use with outdoor appliances; store indoors while not in use." Use only extension cords having an electrical rating not less than the rating of the product. Do not use damaged extension cords. Examine the extension cord before using and replace if damaged.

Do not abuse extension cord and do not yank on any cord to disconnect. Keep cord away from heat and sharp edges. Always disconnect the extension cord from the receptacle before disconnecting the product from the extension cord. If you are using an extension cord, it should always be completely unwound.

Safety Overview

The Owner's Manual is an essential part of the equipment and should be kept in a safe place for reference. Read this manual carefully before using the product - know your equipment. Save these instructions. The Owner's Manual should remain with unit at all times. If you sell the unit, the manual should be handed on to the new owner.

This unit was designed for specific applications. It should not be modified or used for any application other than that for which it was designed.

IMPORTANT: Your pressure washer operates at fluid pressures and velocities high enough to penetrate human and animal flesh, which could result in serious injury or loss of life. Leaks caused by loose fittings, damaged or worn hoses can result in injection injuries.

WARNING: DO NOT treat fluid injection as a simple injury. Fluid injection is very serious. See a physician immediately.

Safety Precautions

The following safety precautions are essential to the safe operation, servicing and storage of your pressure washer. Make sure anyone using this pressure washer or the accessories understands all of the following important safety and equipment precautions.

If safety precautions are overlooked or ignored, personal injury or property damage may occur. Always heed these precautions, as they are essential whenever using, servicing of storing your pressure washer.

1. High-pressure spray can be dangerous if subject to misuse. DO NOT direct the water spray at persons, animals, electrical devices, outlets, or the machine itself.
2. Never touch the water spray.
3. Never hold onto the hose or fittings while operating the pressure washer.
4. Keep operating area clear of all persons. To reduce the risk of injury, do not operate the machine near children.
5. Keep work area free of obstacles. Remove loose objects from spray path. Secure light objects to be cleaned.

continued ...

Important Safety Precautions – *continued*

Safety Precautions – *continued*

6. Always use both hands during operation to maintain complete control of the gun/lance assembly. Expect it to kick back when the gun is triggered.
 7. Always engage the gun safety-lock when not spraying to prevent accidental triggering.
 8. Always wear protective clothing and safety glasses. Protect your eyes and skin from contact with sprayed materials.
 9. Stay alert - watch what you are doing.
 10. DO NOT operate the product when fatigued or under the influence of alcohol or drugs.
 11. Learn how to stop the machine and release pressure quickly. Be thoroughly familiar with the controls.
 12. Outlets with a third prong ground are required. DO NOT use without grounded prong.
 13. If replacement of the plug or cord is needed, use only identical replacement parts.
 14. Check power cords before using. DO NOT use damaged cords as that could reduce machine performance or cause a fatal electric shock.
 15. To reduce the risk of electrocution, keep all connections dry and off the ground. DO NOT touch the plug or outlet with wet hands.
 16. DO NOT pull on the cord to disconnect from an outlet. Never carry your pressure washer by the cord.
 17. To prevent damage, the cord should not be crushed, placed next to sharp objects or near a heat source.
 18. Avoid accidental starts. Move switch on unit to OFF position before connecting or disconnecting cord to electrical outlets.
 19. Disconnect the plug from the outlet when not in use, prior to detaching the high-pressure hose and/or servicing.
 20. Work in a well-ventilated area. The pressure washer should NOT be used in areas where gas vapors may be present. An electric spark could cause an explosion or fire.
 21. To allow free air circulation, the unit should NOT be covered during operation.
 22. DO NOT over reach or stand on an unstable support. Keep good footing and balance at all times when using this equipment.
 23. The narrow pencil-point spray is very powerful. It is NOT recommended for use on painted surfaces, wood surfaces or items attached with an adhesive backing.
 24. Only use pressure washer detergent with this product. Carefully observe all instructions and warnings before using detergents.
 25. DO NOT use this machine to spray chemicals, acids, solvents, insecticides or any flammable material. These products can cause physical injuries to the operator and irreversible damage to the machine.
 26. DO NOT allow the pressure washer to freeze during colder months. Damage as a result of freezing will void the warranty.
 27. Prior to starting the pressure washer in cold weather, be sure ice has not formed in any part of the equipment.
 28. Never tie knots or kink the high-pressure hose as damage could result. DO NOT operate the unit if the high-pressure hose is damaged.
 29. The Gun Safety Lock PREVENTS the trigger from accidentally being engaged. This feature DOES NOT lock trigger in the ON position.
 30. DO NOT allow the pressure washer to run for more than 3 minutes with the gun closed and the motor running. Prolonged operation in bypass mode can result in damage to the pump.
- CAUTION:** The pressure has been pre-set by the manufacturer. DO NOT attempt to adjust the pressure higher than its factory setting. Doing so will damage the pump, void warranty and could result in personal injury or damage.

Water Supply (*Cold Water Only*)

CAUTION: The pressure washer must only be used with clean water; use of unfiltered water or corrosive chemicals will damage the unit.

1. The supply hose must be at least 5/8 inch in diameter.
2. The water supply must be at least twice the pressure washer capacity. (GPM)
3. The water supply pressure must be minimum 20 psi and must not exceed 120 psi.
4. The water supply temperature must not exceed 104°F/40°C.
5. Never use the pressure washer to draw in water contaminated with solvents (e.g. paint thinners, gasoline, oil, etc).
6. Always prevent debris from being drawn into the unit by using a clean water source.
7. Calcium build-up due to hard water is NOT covered by the warranty.

CAUTION: This machine has been designed only for use with pressure washer detergents.

Assembly Instructions

NOTE: Check for visible shipping damage. Shipping damage will cause problems in the operation of this unit. Contact the Customer Service Hotline immediately if there are missing or damaged parts. **DO NOT return this product to the store.**



Step 1

Attach handle to the frame.
Insert bolts and tighten with hardware provided.

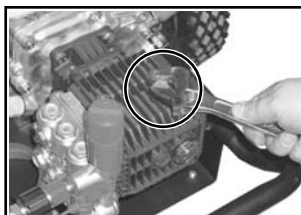

Step 2

Remove red shipping plug from the pump crankcase.



Step 3

Install the provided vented yellow plug/dipstick.

NOTE: Comes with a reversible handle which allows the user the option of high cart or low cart configuration by simply switching handles from one side to the other.

CAUTION: The vented yellow plug/dipstick must be installed. Failure to install the yellow plug/dipstick will damage the pump and void the warranty.

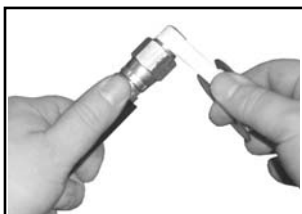

Step 4

Wrap the threads at the end of high-pressure hose with the Teflon tape provided.



Step 5

Connect the high-pressure hose to the spray gun. Tighten with a wrench.



Step 6

Pull back the collar on the lance socket to insert a nozzle. Release the collar.



Step 7

Connect the garden hose to the INLET.
Hand tighten.



Step 8

Connect the high-pressure hose to the OUTLET.
Pull back the collar on the socket.

CAUTION: If the lance is not securely locked into place, it could be ejected under high-pressure when operating the gun, possibly causing injury and/or damage. Poorly mounted nozzles can become projectile. Ensure that the connection is securely made.

Operating Instructions

BEFORE GETTING STARTED: Use only accessories and replacement parts authorized by the manufacturer. The use of original accessories and replacement parts will ensure safe, trouble free operation.

Ensure that anyone operating this equipment has carefully read and understands ALL Warning, Safety Precautions, Assembly and Operating Instructions before using this product.

Before starting pressure washer, always ensure unit is receiving water correctly.

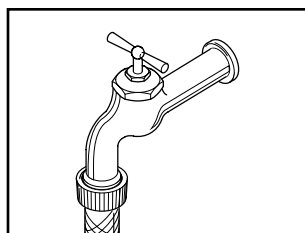

Step 1

Connect the garden hose to the water supply and turn ON water full force.

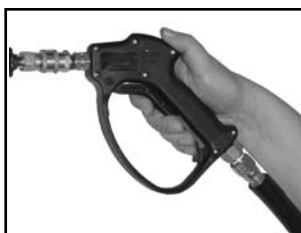

Step 2

Release gun safety-lock and squeeze gun trigger



Step 3

Continue to squeeze gun trigger until a steady stream of water flows from nozzle before releasing trigger.

WARNING: Operating unit without water can damage seals and void the warranty. Always trigger gun until steady stream of water flows from nozzle to ensure unit is receiving water correctly before starting the motor.

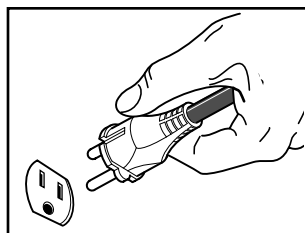

Step 4

Connect the electrical cord to a properly grounded outlet.



Step 5

Release gun safety-lock and squeeze gun trigger

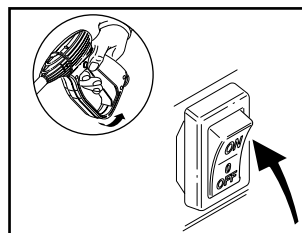

Step 6

Continue to squeeze gun trigger. Turn the motor switch to the ON position.

WARNING: DO NOT touch the plug or outlet with wet hands

CAUTION: Always shutdown the pressure washer when it is not in use. Please refer to the Shutdown Instructions on page 8 for details.

Using the Accessories

CAUTION: Your pressure washer operates at fluid pressures and velocities high enough to cause property damage. Before cleaning any surface, choose an inconspicuous area to test spray pattern and distance for maximum cleaning results. If painted surfaces are peeling or chipping, use extreme caution as pressure washer may remove the loose paint from the surface.

Quick-Connect Nozzles

Four colour-coded quick-connect nozzles are included with the pressure washer:

- Red:** This nozzle produces a high-pressure pencil-point spray (0°) ideal for removing stubborn dirt.
- Yellow:** This nozzle produces a high-pressure flat spray (15°) suitable for cleaning large surface areas.
- Green:** This nozzle produces a high-pressure flat spray (25°) suitable for cleaning larger surface areas.
- Black:** This nozzle produces a low-pressure spray that must be used for application of detergents.

CAUTION: The pencil-point spray (0°) is very aggressive. For most cleaning applications, the flat spray nozzles (15° and 25°) should be used to avoid damage to the surface being sprayed.

NOTE: The intensity of the spray increases as you move the lance closer to the surface.

Your dealer carries a complete line of accessories that compliments your pressure washer and maximizes its usage. Here are just a few of the accessories that are offered:

- Liquid detergents
- Rotary nozzles
- Wet sandblast nozzles

The following KODIAK detergents are available:

- All-Purpose Cleaner
- Deck Wash
- Heavy-duty Degreaser
- House & Window Wash
- Wash 'n Wax

Please contact your local dealer for details, or visit our website at www.kodiakpower.ca

Changing Nozzles

CAUTION: When installing or changing a spray nozzle, always do so with the water turned OFF at the source and the motor turned OFF.



- Step 1.** Discharge residual pressure by pressing and holding the gun trigger until no water comes out of the nozzle.



- Step 2.** Release the gun trigger and engage the gun safety-lock.



- Step 3.** Pull back the collar on the lance socket to insert a nozzle.
- Step 4.** Release the collar and pull sharply on the connection to ensure connection is secure.

CAUTION: When inserting or taking out the spray nozzles from the rubber grommet (located on the handle) use a twisting action so that the rubber grommet does not disengage from the grommet hole.

Working with Detergent

Detergent Overview

To enhance the efficiency of the pressure washer, sometimes it is necessary to use detergents to help loosen tough dirt and grime.

CAUTION: This machine has been designed for use with pressure washer detergents only. The use of other detergents or chemicals may affect the operation of the machine and will void the warranty.

NOTE: To apply detergent, the black-coloured detergent nozzle must be used to activate the low-pressure detergent injection system.

Detergent Application

Step 1 Place suction hose into a container of pressure washer detergent.



Step 2 Pull back the collar on the spray lance to insert detergent nozzle (see page 6).



Step 3 Turn adjustable knob counter-clockwise to open the detergent suction tube.

Step 4 With the motor running, depress the gun trigger to apply detergent to the work area; DO NOT allow detergent to dry on surface.

Step 5 After applying detergent, turn adjustable knob clockwise to close off the detergent suction tube.

Step 6 Release the gun trigger and attach one of the high-pressure nozzles to rinse.

WARNING!

- Never use bleach, chlorine products and other corrosive chemicals
- Never use liquids containing solvents (i.e., paint thinners, gasoline, oils)
- Never use tri-sodium phosphate products
- Never use ammonia products
- Never use acid-based products

These products can cause physical injuries to the operator and irreversible damage to the machine and/or damage the surface being cleaned.

IMPORTANT: When you have finished using detergent, always follow the Cleanup Instructions. Failure to clean properly will cause the injection system to become clogged and inoperable.

Cleanup Instructions

Step 1 Insert detergent suction tube into a clean container (not supplied) with one gallon (4 L) of fresh water.

Step 2 Pull back the collar on the spray lance to insert detergent nozzle (see page 6).



Step 3 Turn adjustable knob counter-clockwise to open the detergent suction tube.

Step 4 With the motor running, press and hold the gun trigger for one minute or until the container of fresh water is empty.

Step 5 After siphoning the water, turn adjustable knob clockwise to close off the detergent suction tube.

Step 6 Release the gun trigger and attach one of the high-pressure nozzles.

Shutdown Instructions

Thermal Protection Valve

Your pressure washer is equipped with a thermal protection valve, located at the base of the pump. If the motor is left running for an extended time with the gun closed, the pressure washer will vent water into the atmosphere through this valve. This will protect against accidental situations but is not designed for repetitive venting.

NOTE: Always shut the motor OFF and engage the gun safety-lock when the pressure washer is not in use.

CAUTION: Never allow the pressure washer to run for more than 3 minutes with the gun closed and the engine running. Prolonged operation in bypass mode can result in damage to the pump.

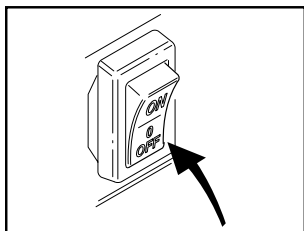

Step 1

Turn the motor switch to the OFF position.

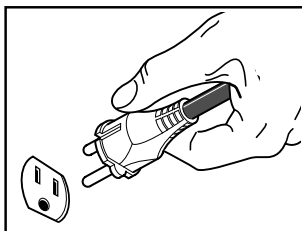

Step 2

Unplug power cord from the outlet.

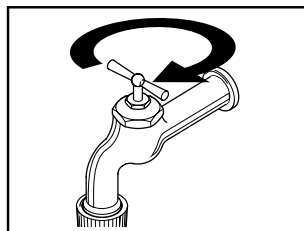

Step 3

Turn OFF the water supply.



Step 4

Discharge residual pressure by pressing and holding the gun trigger until no water comes out the nozzle.



Step 5

Disconnect the high-pressure hose from the water OUTLET.



Step 6

Disconnect the garden hose from the water INLET.



Step 7

Engage the gun safety-lock.

CAUTION: Failure to discharge the residual pressure could result in personal injury due to discharge of high-pressure water.

Storage, Winterizing & Transport

Storage

CAUTION: Always follow Shutdown Instructions on page 8 before storing the pressure washer or the accessories. For your own safety, be sure to turn the engine OFF and discharge the residual pressure (see page 8).

Always store your pressure washer in a location where the temperature will NOT fall below 0°C. Store the machine and accessories in a dry place, protected from freezing. The machine should NOT be placed near an open flame i.e. furnace, hot water heater, etc.

WARNING: The pressure washer pump is susceptible to permanent damage if frozen. Damage as a result of unit freezing is NOT covered by the warranty.

Winterizing

Always store your pressure washer in a location where the temperature will NOT fall below 0°C.

If you must store your pressure washer in a location where the temperature is below 0°C, you can minimize the chance of damage to your machine by utilizing the following procedure:

1. Turn the motor switch OFF.
2. Shut off water supply and relieve pressure in the spray gun by depressing the trigger.
3. Disconnect the garden hose from the unit, but leave the high-pressure hose connected.
4. Connect a short hose (not supplied) to the water inlet of the pressure washer.
5. Place the other end of this hose into container of plumbing antifreeze.
6. Start the motor to circulate the plumbing antifreeze in the pump.
7. Press and hold the gun trigger until the fluid comes out the nozzle. Stop the unit immediately and disconnect from power supply.
8. Discharge residual pressure by pressing and holding the gun trigger, then disconnect the high-pressure hose.

The plumbing antifreeze will help protect against freezing during storage, and help prevent the pistons from sticking.

Transport

Before transport, make sure that the unit is not under pressure and that the unit is in a secure and upright position

Basic Maintenance

IMPORTANT: Always follow the Shutdown Instructions on page 8 before working on the pressure washer or the accessories. For your own safety, be sure to disconnect the plug from the outlet and discharge the residual pressure (see page 8) before carrying out any maintenance.

Cooling System

The air vents, located in and around the pressure washer, must be kept clean and free of any obstructions to ensure proper air-cooling of the motor during operation.

CAUTION: Prevent water from entering the vents of the pressure washer to minimize the risk of damage to the machine and to reduce the risk of shock to the operator.

IMPORTANT: An authorized service centre MUST carry out Maintenance and/or repair of electrical components.

Connections

Connections on pressure washer hoses, gun/lance assembly and spray lances should be cleaned regularly and lubricated with lithium grease to prevent leakage and damage to the O-rings.

If you notice an excessive oil leak, see page 11-12 of the Troubleshooting Section, or contact our Customer Service Hotline at **1-866-939-6666** for further assistance.

Basic Maintenance – *continued*

Nozzle

Clogging of the nozzle causes pump pressure to be high and a distorted spray pattern can result. Cleaning is immediately required with unit turned OFF.

CAUTION: Failure to discharge the residual pressure could result in personal injury due to discharge of high-pressure water

1. Disconnect the nozzle from the lance.
2. Flush the nozzle backwards with water.
3. Reconnect the nozzle to the lance.

Restart the pressure washer and depress the trigger on the spray gun. If the nozzle is still plugged, repeat steps 1-3.

Water Screen

CAUTION: If the screen is not kept clean, the flow of water to the pressure washer will be restricted and the pump may be damaged.

The pressure washer is equipped with a water inlet screen to protect the pump. Clogging of the water screen will restrict flow of water. Cleaning is immediately required with unit turned OFF.

1. Disconnect the garden hose from the INLET.
2. Remove the water screen from the INLET.
3. Clean screen under warm water.
4. Replace screen immediately to prevent any foreign matter from entering the pump.
5. Reconnect the garden hose to the INLET.

CAUTION: Do not damage the screen while removing or cleaning. Any foreign particles entering the pump will damage the unit.

Pump Oil Change

NOTE: Check the pump before every use as well as the system components. Check Pump oil level daily. The pump of the pressure washer will require an oil change once a season or after the first 50 hours operation and then every 50 hours after that. Use only SAE30 non-detergent oil in the pump. The pump also contains an oil sight glass and a dipstick.

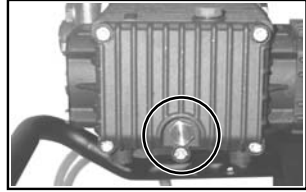

- Step 1.** Use a socket wrench to remove the drain plug, located on the side of the pump.
- Step 2.** Drain the oil into a suitable container. Please dispose of oil properly.
- Step 3.** Replace the oil drain plug securely.

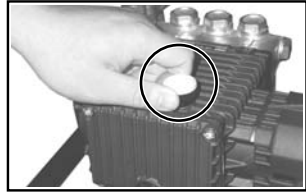

- Step 4.** Remove the yellow oil fill plug from pump.
- Step 5.** Add oil (SAE30 non-detergent motor oil) until the oil level is halfway up the oil sight glass.
- Step 6.** Replace yellow oil fill plug securely.

Troubleshooting

IMPORTANT: Always follow the Shutdown Instructions (see page 8) before working on the pressure washer or the accessories. Always disconnect the pressure washer from the outlet.

Symptom	Possible Cause	Solution
Motor will not start.	On/Off switch is in the "OFF" (O) position.	Turn switch to the "ON" (I) position.
	Power cord is not plugged in.	Plug in the power cord.
	Extension cord is too long. Extension cord is damaged. Extension cord is not proper gauge.	Replace extension cord with either a 25 ft. 14-gauge cord or a 50 ft. 12-gauge cord. See Extension Cord section on page 4.
	Electrical outlet does not supply adequate power.	Check that the circuit is rated for 15 amps.
	Overload Cutout tripped.	Wait 2-3 minutes before restarting.
	Trigger not operating properly.	Call Customer Service hotline.
Circuit breaker trips or fuse blown in fuse box.	Circuit overload.	Check that the circuit is rated for 15 amps. Disconnect all other loads on the circuit.
Motor running, but pump is not building to maximum pressure.	Water supply is restricted.	Open water faucet to full force. Check garden hose for kinks, leaks and blockage.
	Diameter of garden hose is too small.	Use a minimum 5/8" diameter garden hose.
	Water inlet screen clogged.	Remove screen and clean (see page 12).
	Nozzle obstructed.	Clean nozzle (see page 12).
	Unit has been stored in freezing temperatures.	Thaw out unit completely including hose, gun and wand.
Output pressure varies between high and low.	Water supply is restricted.	Open water faucet to full force. Check garden hose for kinks, leaks and blockage.
	Pump is sucking air.	Check that hoses and fittings are airtight. Turn off machine and purge pump by squeezing gun trigger until a steady flow of water emerges through the nozzle.
	Water inlet screen clogged.	Remove screen and clean (see Page 12).
	Nozzle obstructed.	Clean nozzle (see Page 12).
	Calcified gun, hose or spray lance.	Run distilled vinegar through machine.

Troubleshooting – *continued*

IMPORTANT: Always follow the Shutdown Instructions (see page 8) before working on the pressure washer or the accessories. Always disconnect the pressure washer from the outlet.

Symptom	Possible Cause	Solution
No detergent.	Detergent suction tube not properly attached.	Check connection.
	Filter on detergent suction tube is clogged.	Run warm water through filter to remove debris.
	Detergent suction tube damaged or blocked.	Remove obstruction or replace detergent suction tube.
	Detergent is too thick.	Dilute detergent. For best results always use Kodiak detergent.
	Nozzle obstructed.	Clean nozzle (see Page 12).
	Detergent container empty.	Add more detergent.
Garden hose connection leaks.	Loose fittings.	Tighten or replace fittings.
	Missing or worn rubber washer.	Insert new washer.
Gun/lance assembly or spray lance leaks.	Spray lance not attached properly.	Insert the spray lance into the gun/lance assembly. Push in and turn clockwise to lock spray wand in place.
	Broken O-ring.	Call Customer Service hotline to order a replacement O-ring.
Water leaking.	Loose fittings.	Check that all fittings are tight.
Water or oil leaking from bottom of unit.	Loose fittings.	Check that all fittings are tight.
	A small amount of leakage is normal. Excessive leaking may indicate water seals damaged or worn.	If excessive leaking occurs, call Customer Service hotline.
Pump is noisy.	Pump is sucking air.	Check that hoses and fittings are airtight. Turn off machine and purge pump by squeezing gun trigger until a steady flow of water emerges through the nozzle.
Trigger will not move.	Gun safety-lock engaged.	Release safety lock.
Unit will not stop when trigger is released.	Trigger system not operating properly.	Call Customer Service hotline for closest Authorized Repair Centre.

If you encounter any difficulties not listed above, please contact the Customer Service hotline at 1-866-939-6666 or visit our website at www.kodiakpower.ca.

Warranty

Kodiak Electric Pressure Washer Warranty

This product is warranted to be free from defects in materials and workmanship under normal use and service, for a period of one year from the date of purchase, when operated and maintained in accordance with the Maintenance and Operating Instructions supplied with the unit. Hoses, spray lances and other accessories are warranted for 30 days. Warranty period commences on date of purchase.

The warranty herein is expressly conditioned upon the use of the correct electrical requirement, along with the customers compliance with all precautions and instructions in the Owner's Manual.

If a difficulty develops with the product, you should contact the Customer Service Hotline for the location of the closest Authorized Service Centre. Only these locations are authorized to make repairs to the product or affect replacement of defective parts, which will be done at no charge within a reasonable time after receipt of the product.

If the machine is still under warranty, the customer has a valid receipt, and the machine meets the warranty criteria, then the repair will be made at no charge to the customer. Units and parts should be returned at the customer's expense to the nearest Service Centre. Include the original purchase receipt with any claim, making sure to keep a copy for your files. Pack the unit in a strong carton and pad tightly to avoid damage. **Damage in transit is NOT covered by warranty.**

Warranty is void if any devices or accessories other than those distributed or recommended by Kodiak are attached to or connected with the equipment in such a manner that the original factory construction is altered. Warranty is void if repairs are attempted by anyone other than an Authorized Service Centre.

This warranty shall not apply to any problem which is due to misuse, neglect, accident, abuse, improper handling, freezing, normal wear and tear, use of improper detergents/chemicals, or non-compliance with precautions and instructions contained in the Owner's Manual. Warranty is void if the equipment is used for commercial or industrial purposes. This warranty is non-transferable and applies only to products sold in Canada.

John Brooks Company Limited's liability under warranty is limited to repair of the product and/or replacement of parts, and is given to the purchaser in lieu of all other remedies including incidental and consequential charges. There are no expressed warranties other than those specified herein.

Customer Service Hotline:

1-866-939-6666

visit our website:

www.kodiakpower.ca