



DYNABLAST PRESSURE WASHER OWNER'S MANUAL

- 2. Overview & Warnings
- 3. Safety Precautions
- 5. Assembly Instructions
- 6. Operating Instructions
- 7. Using the Accessories
- 8. Working with Detergent
- 9. Shutdown Instructions
- 10. Storage, Winterization & Transport
- 10. Basic Maintenance
- 12. Troubleshooting
- 14. Warranty Information

CUSTOMER SERVICE HOTLINE:

1-888-881-6667

Visit our website:
www.dynablast.ca

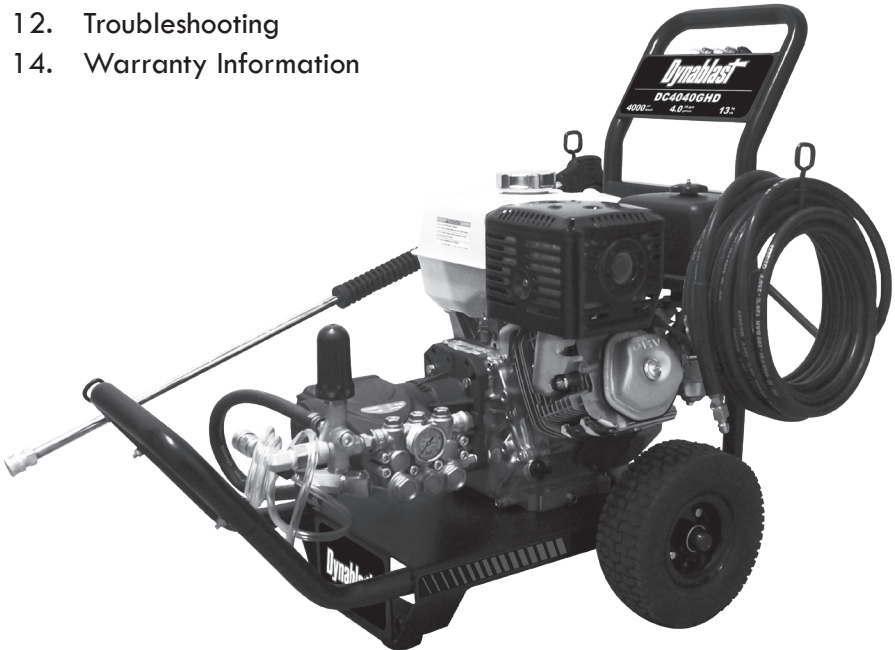

IMPORTANT: Do not operate this equipment until you have read and understand all of the enclosed Owner's Manuals. Carefully **read all Warnings, Safety Precautions, Assembly and Operating Instructions, Maintenance and Storage information.**

MACHINE OVERVIEW

Note: Check for visible shipping damage. Shipping damage will cause problems in the operation of this unit. Contact the Customer Service Hotline immediately if parts are missing or damaged. **DO NOT return this product to the Dealer.**

NOTE: Any instructions that are bound by this grey box are **ELECTRIC MODEL SPECIFIC instructions only.** If you purchased a gas unit, please disregard all information within these grey boxes.

ITEM DESCRIPTION

- 1 Nozzle Connector
- 2 Spray Lance
- 3 Gun with Safety-Lock
- 4 High-Pressure Hose
- 5 Reversible Cart Handle
- 6 Spray Nozzles
- 7 External Unloader
- 8 Water Inlet
- 9 Water Outlet
- 10 Front Guard
- 11 Pump
- 12 Pump Oil Dipstick
- 13 Engine
- 14 Thermal Protector
- 15 Bypass Loop
- 16 Chemical Injector

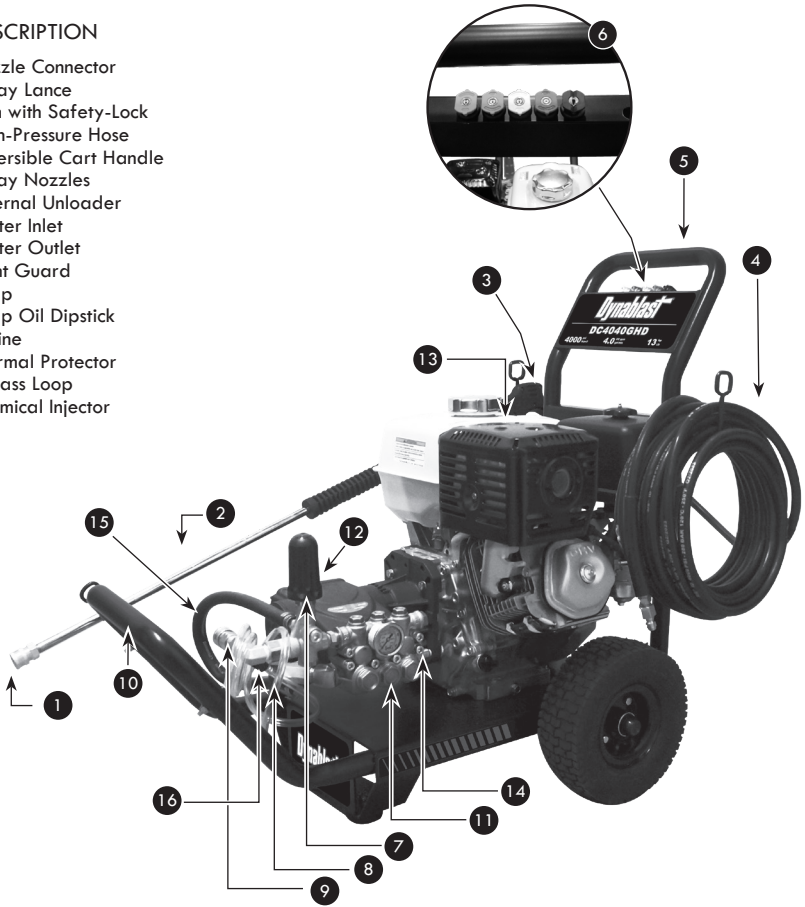

WARNING!

- Never** aim water spray at persons, animals, electrical devices or the machine itself.
- Never** touch water spray.
- Never** use hot water.
- Never** operate pressure washer without the water turned on.
- Never** drink alcohol or use drugs while operating this equipment.
- Never** allow the pressure washer to freeze.

Always wear safety glasses and protective clothing.

Always ensure that you have read and understand all of the enclosed Owner's Manuals before operating this equipment.



IMPORTANT SAFETY PRECAUTIONS

SAFETY OVERVIEW

This unit was designed for specific applications. It should not be modified or used for any application other than that for which it was designed.

The Owner's Manual is an essential part of the pressure washer and should be kept in a safe place for future reference. If you sell the pressure washer, all manuals should be provided to the new owner. Read this manual carefully before using the product – know your equipment.

Save these instructions. The Owner's Manual should remain with the unit at all times.

IMPORTANT: Your pressure washer operates at fluid pressures and velocities high enough to penetrate human and animal flesh, which could result in serious injury or loss of life. Leaks caused by loose fittings, damaged or worn hoses can result in Injection Injuries.

WARNING: DO NOT treat fluid injections as a simple injury. Fluid injection is very serious. See a physician immediately.

SAFETY PRECAUTIONS

The following safety precautions are essential for the safe operation of your pressure washer. Make sure anyone who may be using the pressure washer is familiar with these important safety and equipment precautions.

If safety precautions are overlooked or ignored, personal injury or property damage may occur. Always heed these precautions as they are essential when using any mechanical equipment.

1. Before transport, ensure that the fuel is shut off and that the unit is in the upright position to avoid fuel spillage. Fuel vapor or spilled fuel may ignite.
2. **High-pressure spray can be dangerous if subject to misuse. DO NOT direct the water spray at persons, animals, electrical devices or the machine itself.**
3. Never touch the water spray.
4. Never hold on to the hose or fittings while operating the pressure washer.
5. Keep operating area clear of all persons. To reduce the risk of injury, DO NOT operate the machine near children.
6. Keep work area free of obstacles. Remove loose objects from spray path. Secure light objects to be cleaned.
7. Always use both hands during operation to maintain complete control of the gun/lance assembly. Expect it to kick back when the gun is triggered.
8. Always engage the gun safety-lock when not spraying to prevent accidental triggering.
9. Always wear protective clothing and safety glasses. Protect your eyes and skin from contact with sprayed materials.
10. Stay alert – watch what you are doing.
11. DO NOT operate the product when fatigued or under the influence of alcohol or drugs.
12. Learn how to stop the machine and release pressure quickly. Be thoroughly familiar with the controls.

* ELECTRIC MODELS ONLY *

13. Outlets with a third prong ground are required. DO NOT use without grounded prong.
 14. If replacement of the plug or cord is needed, use only identical replacement parts.
 15. Check power cords before using. DO NOT use damaged cords as that could reduce machine performance or cause fatal electric shock.
 16. To reduce the risk of electrocution, keep all connections dry and off the ground. DO NOT touch the plug or outlet with wet hands.
 17. DO NOT pull on the cord to disconnect from an outlet. Never carry your pressure washer by the cord.
 18. To prevent damage, the cord should not be crushed, placed next to sharp objects or near a heat source.
 19. Avoid accidental starts. Move switch on unit to OFF position before connecting or disconnecting cord to electrical outlets.
 20. Disconnect the plug from the outlet when not in use, prior to detaching the high-pressure hose and/or servicing.
 21. Parts of the engine get extremely hot during operation. Never touch the engine while it is hot or running; allow engine to cool down and avoid injury.
 22. DO NOT add fuel while the engine is running or still hot. Doing so could result in a fire or explosion. (Please refer to the Engine Owner's Manual for fueling procedures)
 23. DO NOT allow the hose to touch any part of the engine while it is running or hot. A hot engine could melt through the hose.
 24. **Work in a well-ventilated area. The pressure washer should not be used in areas where gas vapors may be present. A spark could cause an explosion or fire.**
 25. To allow free air circulation, DO NOT cover the pressure washer during operation.
- WARNING:** A running engine gives off carbon monoxide, an odorless, colourless, poison gas. Breathing carbon monoxide can cause headache, fatigue, dizziness, vomiting, confusion, seizures, nausea, fainting or death.
Some chemicals or detergents may be harmful if inhaled or ingested, causing severe nausea, fainting or poisoning.
- ONLY OPERATE THE PRESSURE WASHER OUTSIDE!**
26. DO NOT over reach or stand on an unstable support. Keep good footing and balance at all times when using this equipment.
 27. The narrow pencil-point spray is very powerful. It is NOT recommended for use on painted surfaces, wood surfaces or items attached with an adhesive backing.
 28. Only use pressure washer detergent with this product. Carefully observe all instruction and warnings before using detergents.
 29. DO NOT use this machine to spray chemicals, acids, solvents, insecticides or any flammable material. These products can cause physical injuries to the operator and irreversible damage to the unit.

IMPORTANT SAFETY PRECAUTIONS (CONT'D)

SAFETY PRECAUTIONS (CONT'D)

30. DO NOT allow your pressure washer to freeze during the colder months. Damage as a result of freezing will void the warranty.
31. Prior to starting the pressure washer in cold weather, be sure that ice has not formed in any part of the equipment.
32. Never tie knots or kink the high-pressure hose as damage could result. DO NOT operate the unit if the high-pressure hose is damaged.
33. The gun safety Lock PREVENTS the trigger from accidentally being engaged. This safety feature DOES NOT lock the trigger in the ON position.
34. Securely connect the discharge lines before starting the pump. An insecurely connected line may cause personal injury and/or property damage.
35. To avoid serious injury and damage to the unit DO NOT operate this pressure washer with any components rated less than the pressure rated for each model (i.e.: spray guns, hoses, hose couplings, etc...)
36. DO NOT allow the pressure washer to run for more than 3 minutes with the gun closed and engine running. Prolonged operation in bypass mode can result in damage to the pump.
37. Shut the engine OFF if you are not using the pressure washer.

CAUTION: The pressure has been preset by the manufacturer. DO NOT attempt to adjust the pressure higher than its factory setting. Doing so will damage the pump, void the warranty and could result in personal injury or damage.

CAUTION: This machine has been designed for use with pressure washer detergents only.

WATER SUPPLY (Cold Water Only)

This pressure washer must only be used with clean water; use of unfiltered water or corrosive chemicals will damage the pressure washer.

1. The supply hose should be at least 5/8" in diameter.
2. The water supply must be at least twice to the flow rate of the pressure washer. (GPM)
3. The water supply pressure must be a minimum of 20psi and must not exceed 120psi.
4. The water supply temperature must not exceed 40°C/104°F.
5. Never use the pressure washer to draw in water contaminated with solvents, e.g. paint thinners, gasoline, oil, etc.
6. Always prevent debris from being drawn into the unit by using a clean water source.
7. Calcium build-up due to hard water is NOT covered by the warranty.

ELECTRIC MODELS ONLY

GROUNDING INSTRUCTIONS

This product must be grounded. If it should malfunction or break-down, grounding provides a path of least resistance for the electric current to reduce the risk of electric shock. This product is equipped with a cord that includes a grounding plug. You must make sure that the plug is inserted into an outlet that is properly installed and grounded in accordance with all local codes and ordinances.

Warning: Improper connection can result in a risk of electrocution. Check with a licensed electrician if you are unsure as to whether the outlet is properly grounded.

DO NOT modify the plug provided with the unit; if it will not fit the outlet, have a proper outlet installed by a licensed electrician. Do not use any type of adaptor with this product.

EXTENSION CORDS

Extension cords are NOT recommended for this product. If an extension cord must be used, the following requirements must be met:

- 14-3 gauge minimum wire size up to 25 ft. cord. (120V)
- 12-3 gauge minimum wire size up to 50 ft. cord. (120V)
- 10-3 gauge minimum wire size up to 50 ft. cord. (240V)
- Use only 3-wire extension cords that have 3-prong grounding type plugs and 3-pole cord connectors that accept the plug from the unit.

Use only extension cords that are intended for outdoor use. These extension cords are identified by the marking "Acceptable for use with outdoor appliances; store indoors while not in use." Only use extension cords with a rating no less than that of the rating of the product. Do not use damaged extension cords. Examine the extension cord before using and replace if damaged.

Do not abuse the extension cord and do not yank on any cord to disconnect. Keep cord away from heat and sharp edges. Always disconnect the extension cord from the receptacle before disconnecting the product from the extension cord. If you are using an extension cord, it should always be completely unwound.

Note: If your pressure washer is equipped with a Time Delay Shut Down system. This will automatically turn off your machine when you close the trigger gun and leave it closed for 30 seconds. It will restart when you pull the trigger and start spraying. It is always recommended to turn off the master switch when not in use, or at end of day. The electrical timer box should only be serviced by authorized Dynablast dealers, or trained electrical professionals. The box must always be tightly sealed. Never open the box as there is a risk of exposure to high voltage.

ASSEMBLY INSTRUCTIONS

NOTE: Check for visible shipping damage. Shipping damage will cause problems in the operation of this unit. Contact the Customer Service Hotline immediately if there are missing or damaged parts.
DO NOT return this product to the Dealer!

NOTE: This product features an innovative reversible handle which allows the user the option of high cart or low cart configuration by simply switching handles from one side to the other.

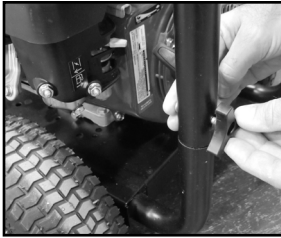

STEP 1

Determine desired position and attach handle to the frame. Insert bolts and tighten with hardware provided.

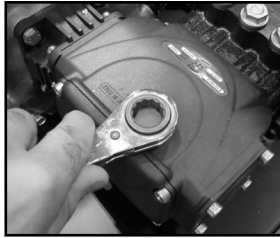

STEP 2

Remove the red shipping plug from the pump crankcase.

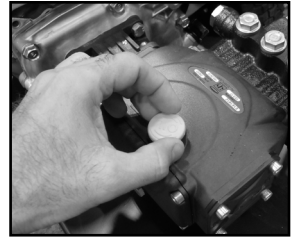

STEP 3

Install the provided vented yellow plug/dipstick.

CAUTION: The vented yellow plug/dipstick must be installed. Failure to install the yellow plug/ dipstick will damage the pump and void the warranty.

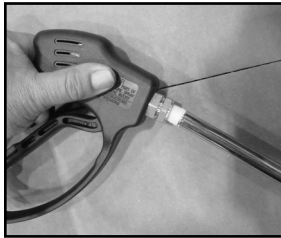

STEP 4

Wrap the threads of the lance with Teflon Tape provided. Thread lance into spray gun.

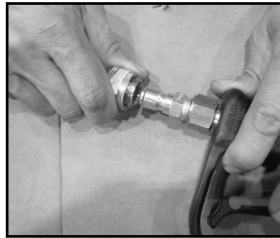

STEP 5

Pull back the collar on the high-pressure hose socket to connect to the spray gun. Release collar.



STEP 6

Pull back the collar on the lance socket to insert a nozzle. Release collar.



STEP 7

Connect the garden hose to the **INLET**. Hand tighten.

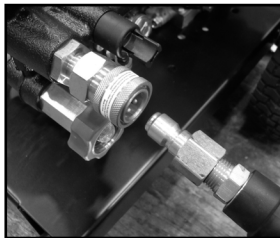

STEP 8

Connect the high-pressure hose to the **OUTLET**. Pull back the collar on the socket.

CAUTION: If the spray nozzle is not securely locked into place, it could be ejected under high-pressure when operating the gun, possible causing injury and/or damage. Poorly mounted nozzles can become projectile. Ensure that the connection is securely made.

OPERATING INSTRUCTIONS

WARNING: THE ENGINE IS SHIPPED WITHOUT OIL. Fill engine with the recommended oil to the indicated level before operating the unit. Engines will not start without the correct oil level. Please refer to the Engine Owner's Manual for details.

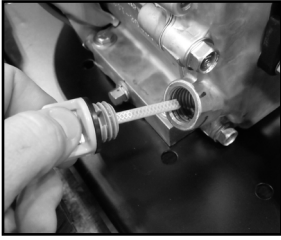

STEP 1

Check engine oil. Refer to the Engine Owner's Manual.



STEP 2

Fill gas tank. Refer to the Engine Owner's Manual.

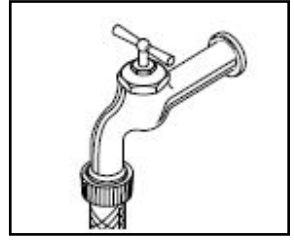

STEP 3

Connect the garden hose to the water supply and turn ON water full force.



STEP 4

Release the gun safety-lock and squeeze gun trigger.



STEP 5

Continue to squeeze gun trigger until a steady stream of water flows from the nozzle before releasing the trigger.

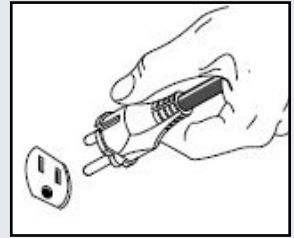

STEP 6

Connect electrical cord to a properly grounded outlet.
ELECTRIC MODELS ONLY

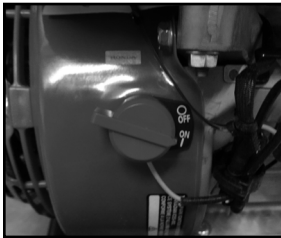

STEP 7

Start engine and throttle up to full RPMs. Refer to the Engine Owner's Manual.

WARNING: Operating unit without water can damage seals and void the warranty. Always trigger gun until steady stream of water flows from the nozzle to ensure unit is receiving water correctly before starting the engine. Your engine is equipped with a "low-oil" shut-off. If there is not enough oil, the engine will shut off.

ENGINE QUICK START INSTRUCTIONS

Please refer to the Engine Owner's Manual for more details.

- Step 1: Turn the fuel valve on.
- Step 2: If the engine is cold, pull choke lever to the left or closed position.
- Step 3: Move throttle control about 2/3 of the way toward the FAST position.
- Step 4: Turn the engine switch to the ON position.
- Step 5: Pull the starter grip to start the engine.
- Step 6: Push choke lever to the right or the open position.
- Step 7: Throttle up to full RPMs. Refer to the Engine Owner's Manual for details.
- Step 8: Press the gun trigger gently.
DO NOT pump the trigger rapidly between ON and OFF settings.

CAUTION: Always shutdown the pressure washer when it is not in use. Please refer to the shutdown instructions on page 9 for more details.

USING THE ACCESSORIES

CAUTION: Your pressure washer operates at fluid pressures and velocities high enough to cause property damage. Before cleaning any surface, choose an inconspicuous area to test spray pattern and distance for maximum cleaning results. If painted surfaces are peeling or chipping, use extreme caution as pressure washer may remove the loose paint from the surface.

QUICK-CONNECT NOZZLES

Five colour-coded quick-connect nozzles are included with the pressure washer.

- RED:** This nozzle produces a high-pressure pencil-point spray (0°) ideal for removing stubborn dirt.
- YELLOW:** This nozzle produces a high-pressure flat spray (15°) suitable for cleaning concrete, brick & other porous surfaces.
- GREEN:** This nozzle produces a high-pressure flat spray (25°) suitable for cleaning painted surfaces, wood, siding and fences.
- WHITE:** This nozzle produces a wide, high-pressure, flat spray (40°) suitable for cleaning windows and screens.
- BLACK:** This nozzle produces a low-pressure spray that must be used for application of detergents.

CAUTION: The red nozzle (0°) is very aggressive. For most cleaning applications, the flat spray nozzles (15°, 25°, and 40°) should be used to avoid damage to the surface being sprayed.

NOTE: The intensity of the spray increases as you move the nozzle closer to the surface.

Your dealer carries a complete line of accessories that compliments your pressure washer and maximizes its usage.

Here are just a few of the accessories that are offered:

- Liquid Detergents
- Rotary Nozzles
- Wet Sandblast Nozzles

CHANGING NOZZLES

CAUTION: When installing or changing a spray nozzle, always do so with the water turned OFF at the source and the engine turned OFF.



STEP 1

Discharge residual pressure by pressing and holding the gun trigger until no water comes out of the nozzle.



STEP 2

Release the gun trigger and engage the gun safety-lock.



STEP 3

Pull back the collar on the lance socket to insert one of the nozzles.

STEP 4

Release the collar and pull sharply on the connection to ensure it is secure.

CAUTION: When inserting or removing the spray nozzles from the rubber grommet (located on the handle) use a twisting motion so that the rubber grommet does not disengage from the grommet hole.

WORKING WITH DETERGENT

DETERGENT OVERVIEW

To enhance the efficiency of the pressure washer, sometimes it is necessary to use detergents to help loosen tough dirt and grime.

CAUTION: This machine has been designed for use with pressure washer detergents only. The use of other detergents or chemicals may affect the operation of the machine and will void the warranty.

NOTE: To apply detergent, the black coloured detergent nozzle must be used to activate the low-pressure detergent injection system.

DETERGENT APPLICATION

STEP 1

Place the suction hose into a container of pressure washer detergent.



STEP 2

Pull back the collar on the spray lance to insert the detergent nozzle. (see page 7)

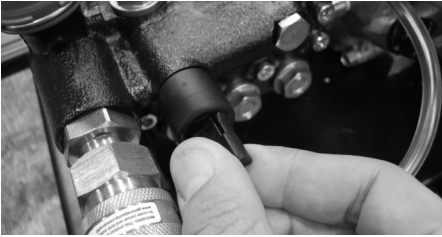

STEP 3

Turn the adjustment knob counter-clockwise to open and meter the desired amount of chemical injection.

STEP 4

With the engine running, depress the gun trigger to apply detergent to the work area, DO NOT allow detergent to dry.

STEP 5

After applying detergent, turn adjustable knob clockwise to close off the detergent chemical injector.

STEP 6

Release the gun trigger and attach one of the high-pressure nozzles.

WARNING!

- Never use bleach, chlorine products and other corrosive chemicals
- Never use liquids containing solvents (i.e. paint thinners, gasoline, oils)
- Never use tri-sodium phosphate products
- Never use ammonia products
- Never use acid-based products

These products can cause physical injuries to the operator and irreversible damage to the machine and/or damage the surface being cleaned.

IMPORTANT: When you have finished using detergent, always follow the Cleanup Instructions. Failure to clean properly will cause the injection system to become clogged and inoperable.

CLEANUP INSTRUCTIONS

STEP 1

Insert detergent suction tube into a clean container (not supplied) with one gallon (4L) of fresh water.

STEP 2

Pull back the collar on the spray lance to insert the detergent nozzle (see page 7).



STEP 3

Turn the adjustment knob counter-clockwise to open and meter the desired amount of chemical injection.

STEP 4

With the engine running, press and hold the gun trigger for one minute or until the container of fresh water is empty.

STEP 5

After siphoning the water, turn adjustable knob clockwise to close off the detergent chemical injector.

STEP 6

Release the gun trigger and attach one of the high-pressure nozzles.

SHUTDOWN INSTRUCTIONS

THERMAL PROTECTION VALVE

Your pressure washer is equipped with a thermal protection valve, located at the base of the pump. If the engine is left running for an extended period of time with the gun closed, the pressure washer will vent water into the atmosphere through this valve. This will protect against accidental situations but is not designed for repetitive venting.

NOTE: Always shut the engine OFF and engage the gun safety-lock when the pressure washer is not in use.

CAUTION: Never allow the pressure washer to run for more than 3 minutes with the gun closed and the engine running. Prolonged operation in bypass mode can result in damage to the pump.

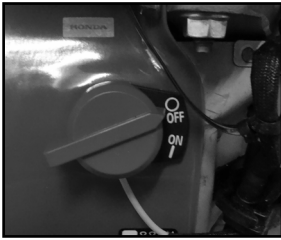

STEP 1

Throttle down and turn of engine switch.

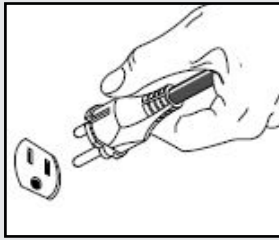

STEP 2

Unplug power cord from outlet.
ELECTRIC MODELS ONLY

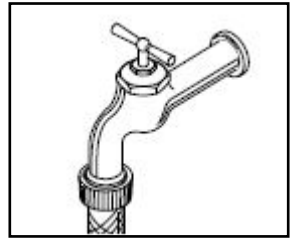

STEP 3

Turn OFF the water supply.



STEP 4

Discharge residual pressure by pressing and holding the gun trigger until no water comes out the nozzle.

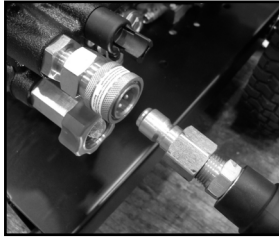

STEP 5

Disconnect the high-pressure hose from the water OUTLET.

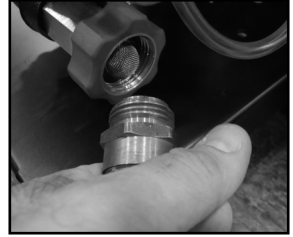

STEP 6

Disconnect the garden hose from the water INLET.



STEP 7

Engage the safety-lock.

CAUTION: Failure to discharge the residual pressure could result in personal injury due to discharge of high-pressure water.

STORAGE, WINTERIZING & TRANSPORT

STORAGE

CAUTION: Always follow the proper Shutdown Instructions on page 9 before storing the pressure washer or accessories. For your own safety, be sure to turn the engine OFF and discharge the residual pressure (see page 9.)

Always store your pressure washer in a location where the temperature will NOT fall below 0°C. Store the machine and accessories in a dry place, protected from freezing. The machine should NOT be placed near an open flame i.e. furnace, hot water heater, etc.

WARNING! The pressure washer pump is susceptible to permanent damage if frozen. Damage as a result of the unit freezing is NOT covered by the warranty.

WINTERIZING

Always store your pressure washer in a location where the temperature will NOT fall below 0°C.

CAUTION: Always remove gasoline from the engine if storing the pressure washer indoors.

If you must store your pressure washer in a location where the temperature is below 0°C, you can minimize the chance of damage to your machine by utilizing the following procedure:

1. Turn Motor switch OFF (*ELECTRIC MODELS ONLY*)
2. Shut off water supply and relieve pressure in the spray gun by depressing the trigger.
3. Disconnect the garden hose from the unit, but leave the high-pressure hose connected.

BASIC MAINTENANCE

IMPORTANT: Always follow the Shutdown Instructions on page 9 before working on the pressure washer or the accessories. For your own safety, be sure to turn the engine OFF and discharge the residual pressure (see page 9) before carrying out any maintenance.

NOZZLE

Clogging off the nozzle causes pump pressure to pulsate and a distorted spray pattern can result. Cleaning is immediately required with unit turned OFF.

CAUTION: Failure to discharge the residual pressure could result in personal injury due to discharge of high-pressure water.

- Step 1: Disconnect the nozzle from the lance.
Step 2: Flush the nozzle backwards with water.
Step 3: Reconnect the nozzle to the lance.

Restart the pressure washer and depress the trigger on the spray gun. If the nozzle is still plugged, repeat steps 1 through 3.

4. Connect a short hose (not supplied) to the water inlet of the pressure washer.
5. Place the other end of this hose into a container of plumbing anti-freeze.
6. Start the engine to circulate the plumbing anti-freeze in the pump.
7. Press and hold the gun trigger until the fluid comes out the nozzle. Turn the engine OFF immediately.
8. Discharge residual pressure by pressing and holding the gun trigger, then disconnect the high-pressure hose.

The plumbing anti-freeze will help protect against freezing during storage and help prevent the pistons from sticking.

TRANSPORT

Turn off fuel valve before storing or transporting machine. Before transport, make sure that the unit is not under pressure and that the unit is in a secure and upright position.

CAUTION: Investigate and abide by your local laws in the transportation of engines with gasoline in them.

CAUTION: If gasoline is left in the engine during the winter months, the gasoline can go bad and even damage the engine's carburetor. Please see Honda manual for long term storage recommendations.

CONNECTIONS

Connections on hoses, the gun and spray lance should be cleaned regularly.

COOLING SYSTEM *ELECTRIC MODELS ONLY*

The air vents, located in and around the pressure washer, must be kept clean and free of any obstructions to ensure proper air-cooling of the motor during operation.

BASIC MAINTENANCE (CONT'D)

WATER SCREEN

CAUTION: If the screen is not kept clean, the flow of water to the pressure washer will be restricted and the pump maybe damaged.

The pressure washer is equipped with a water inlet screen to protect the pump. Clogging of the water screen will restrict flow of water. Cleaning is immediately required with unit turned OFF.

1. Disconnect the garden hose from the INLET.
2. Remove the water screen from the INLET.
3. Clean screen under warm water.
4. Replace screen immediately to prevent any foreign matter from entering the pump.
5. Reconnect the garden hose to the INLET.

CAUTION: Do not damage the screen while removing or cleaning. Any foreign particles entering the pump will damage the unit.

ENGINE

To ensure proper care of the engine, be sure to follow the manufacturer's maintenance schedule, routine inspection procedures and maintenance procedures.

Please refer to the Engine Owner's Manual for details on maintenance of the engine.

WARNING: Improperly maintaining the engine, or failure to correct a problem before operation can cause a malfunction in which you can be seriously hurt or killed.

NOTE: In the unlikely event that you have a problem with the engine, you must contact a Honda Service Centre. Please call the Honda toll-free hotline at **1-888-946-6329** to locate the nearest Authorized Service Centre.

PUMP OIL CHANGE

NOTE: Check the pump before every use as well as the system components. Check pump oil level daily. The pump of the pressure washer will require an oil change once a season or after the first 50 hours of operation and then every 50 hours after that. Use only 15W40 HD Motor Oil in the pump. The pump also contains an oil sight glass and dipstick.

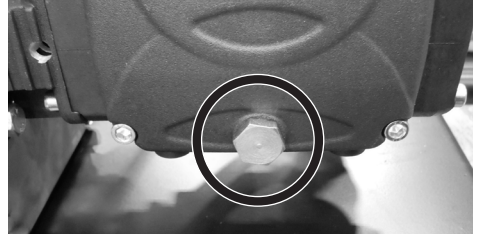

STEP 1

Use a socket wrench to remove the drain plug located on the side of the pump.

STEP 2

Drain the oil into a suitable container. Please dispose of oil properly.

STEP 3

Replace the oil drain plug securely.

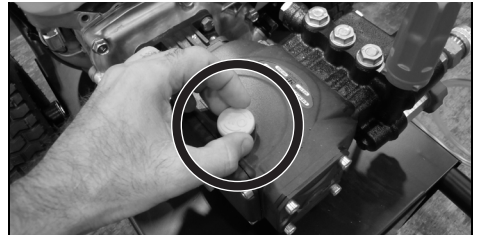

STEP 4

Remove the yellow oil fill plug from pump.

STEP 5

Add oil (15W40 HD Motor Oil) until the oil level is halfway up the oil sight glass.

STEP 6

Replace the yellow oil fill plug securely.

TROUBLESHOOTING

IMPORTANT: Always follow the Shutdown Instructions (see page 9) before working on the unit or the accessories. Always discharge residual pressure and turn the engine OFF.

SYMPTOM	POSSIBLE CAUSE	SOLUTION
Engine will not start.	No gasoline.	Fill gas tank.
	Oil level low.	Add oil.
	Engine throttle is not in correct position.	Position throttle 1/3 of the way towards FAST position.
	Choke in wrong position.	Pull choke lever to CLOSED position for cold engine.
	Excess pressure built up in the unit.	Press gun trigger to discharge residual pressure (see page 9)
	On/Off switch is in the "OFF" position	Turn switch to the "ON" (I) position.
	Power cord is not plugged in.	Plug in the power cord.
	Extension cord is too long. Extension cord is damaged. Extension cord is not proper gauge.	Replace extension cord with either a 25 ft. 14-gauge cord or a 50 ft. 12-gauge cord. See Extension Cord section on page 4.
	Electrical outlet does not supply adequate power.	Check that the circuit is rated for 15 amps.
	Overload Cutout tripped.	Wait 2-3 minutes before restarting.
Trigger not operating	Call Customer Service hotline.	
Unit restarts unexpectedly	Unit is equipped with Time Delay Shutdown	1. Check for water leaks 2. Check and replace gun if internal valve leaks *E.M.O.*
Circuit breaker trips or fuse blown in fuse box.	Circuit overload.	Check that the circuit is rated for 15 amps. Disconnect all other loads on the circuit. *ELECTRIC MODELS ONLY*
Engine is running, but pump is not delivering maximum pressure.	Water supply is restricted.	Open water faucet fully. Check the garden hose for kinks, leaks and blockages.
	Worn or broken engine key.	See dealer.
	Diameter of garden hose is too small.	Use a minimum 5/8" diameter garden hose.
	Water inlet screen clogged.	Remove screen and clean (see page 11).
	Nozzle obstructed.	Clean nozzle (see page 10).
	Incorrect cleaning nozzle is installed.	Install the correct nozzle for the cleaning application. (see page 7).
	Unit has been stored in freezing temperatures.	Thaw out unit completely, including hose, gun and wand.
Output pressure varies between high and low.	Water supply is restricted.	Open water faucet fully. Check garden hose for kinks, leaks and blockages.
	Pump is sucking air.	Check that hoses and fittings are airtight. Turn off machine and purge the pump by squeezing the gun trigger until a steady flow of water emerges through the nozzle.
	Water inlet screen clogged.	Remove screen and clean (see page 11).
	Nozzle obstructed.	Clean nozzle (see page 10).
	Calcified gun, hose or spray lance.	Run distilled vinegar through machine.
	Leaks downstream of unloader	Check for leaks downstream of the unloader valve. If no leaks, unloader may have to be serviced.

ELECTRIC MODELS ONLY

TROUBLESHOOTING (CONT'D)

IMPORTANT: Always follow the Shutdown Instructions (see page 9) before working on the unit or the accessories. Always discharge residual pressure and turn the engine OFF.

SYMPTOM	POSSIBLE CAUSE	SOLUTION
Garden hose connection leaks.	Loose fittings.	Tighten or replace fittings.
	Missing or worn rubber washer.	Insert new washer.
Gun/lance assembly or spray lance leaks.	Spray lance not attached properly.	Ensure the spray lance is connected properly. Hand tighten the connection.
	Broken O-Ring.	Call Customer Service Hotline to order a replacement O-Ring.
No detergent.	Black-coloured detergent nozzle not attached.	Attach the black-coloured detergent nozzle (see page 7).
	Adjustable detergent knob in closed position.	Open adjustable detergent knob (see page 8).
	Detergent suction tube not properly attached.	Check connection.
	Filter on detergent suction tube is clogged.	Run warm water through filter to remove debris.
	Detergent suction tube damaged or blocked.	Remove obstruction or replace detergent suction tube.
	Nozzle obstructed.	Clean nozzle (see page 10).
	Detergent container empty.	Replace detergent container.
Water leaking.	Loose fittings.	Check that all fittings are tight.
Water or oil leaking from bottom of unit.	Loose fittings.	Check that all fittings are tight.
	A small amount of leakage is normal. Excessive leaking may indicate water seals are damaged or worn.	If excessive leaking occurs, call Customer Service Hotline.
Pump is noisy.	Pump is sucking air.	Check that hoses and fittings are airtight. Turn off machine and purge pump by squeezing gun trigger until a steady flow of water emerges through the nozzle.
Trigger will not move.	Gun safety-lock engaged.	Release safety lock.

If you encounter any difficulties not listed above, please contact the Customer Service Hotline.

CUSTOMER SERVICE HOTLINE:

1-888-881-6667

Visit our website:
www.dynablast.ca

WARRANTY INFORMATION

PRESSURE WASHER WARRANTY

This product is warranted to be free from defects in materials and workmanship under normal use and service for a period of one year from the date of purchase when operated and maintained in accordance with the Maintenance and Operating Instructions supplied with the unit. Hoses, spray lances and other accessories are warranted for 30 days. Warranty period commences on the date of purchase.

The warranty herein is expressly conditioned upon the customer's compliance with all precautions and instructions contained in the Owner's Manual.

If the machine is still under warranty, the customer has a valid receipt, and the machine meets the warranty criteria, then the repair will be made at no charge to the customer. Units and parts should be returned at the customer's expense to the nearest Authorized Service Centre. Include original purchase receipt with and claim, making sure to keep a copy for your files. Be sure to pack the unit in a strong carton and pad tightly to avoid damage. **Damage in transit is NOT covered by warranty.**

Warranty is void if any devices or accessories other than those distributed or recommended by Dynablast are attached to or connected with the equipment in such a manner that the original factory construction is altered.

Warranty is void if repairs are attempted by anyone other than an Authorized Service Centre. In the event that a difficulty develops with the product, you should contact the nearest Authorized Service Centre. Only these locations are authorized to make repairs to the product or affect the replacement of defective parts, which will be done at no charge within a reasonable amount of time after receipt of the product.

This warranty shall not apply to any problem which is due to misuse, neglect, accident, abuse, improper handling, freezing, normal wear and tear, use of improper detergents/ chemicals, or non-compliance with precautions and instructions contained in the Owner's Manual. This warranty is non-transferable.

The liability of John Brooks Company Limited is limited to repair of the product and/or replacement of parts, and is given to the purchaser in lieu of all other remedies including incidental and consequential charges. There are no expressed warranties other than those specified herein.

PUMP WARRANTY - 5 YEARS

GAS ENGINE WARRANTIES

HONDA - Honda engines are warranted for a period of two years by the Honda Motor Company Limited. In the unlikely event that you have a problem with the engine, you must contact an authorized Honda Service Center. Please call the Honda toll-free hotline at 1-888-946-6329 to locate the Service Center nearest you.

KODIAK - Kodiak engines are warranted for a period of one year by Kodiak Power Equipment. If you experience any problem with your Kodiak engine, contact the Kodiak customer service toll-free hotline at 1-888-881-6667.

ELECTRIC MOTOR WARRANTIES

TECHTOP - Techttop electric motors are covered by the manufacturer by a period of 18 months. If you experience any problems with your Techttop electric motor, please contact the manufacturer, www.techttopcanada.com.

BALDOR - Baldor electric motors are covered by the manufacturer by a period of one year. If you experience any problems with your Baldor electric motor, please call the manufacturer, www.baldor.com.

CUSTOMER SERVICE HOTLINE:

1-888-881-6667

Visit our website:
www.dynablast.ca